



Contract Name: **Supply, Delivery and Installation of Various Equipment for the project entitled "Building and Empowering a Resilient Community through Science and Technology in Las Nieves, Agusan del Norte"**

Location of Contract: **Las Nieves, Agusan del Norte**

**BID BULLETIN NO. 2021-04**

Date: May 21, 2021

**Subject: NOTICE OF ADDENDUM**

This Bid Bulletin No. 2021-04 is issued to modify or amend items in the Bidding Documents:

1. Informing all prospective bidders of the following amendment/s under Section VII – Technical Specifications.

ITEM	FROM	TO
1 unit Coffee Roaster	Power: single phase, 220V/50 or 60Hz Dimension: 120 (l) cm x 83 (w) cm x 153 (h) cm	Power: single phase, 220V/60Hz Dimension: Manufacturer's standard, should not exceed 2m (l) x 1.5m (w)
1 unit Coffee Bean Grinder	Burr Speed: 2200 rpm Feeding inlet: 45mm Ø	Burr Speed: 1400 - 2200 rpm <i>-Deleted-</i> Add Machine Size: Manufacturer's standard, should not exceed 1.5m (l) x 1.5m (w)
1 unit Coffee Dehuller Machine w/ Electric Motor	Engelbergtype coffee dehuller (DH-300EM) Dimension: 855mm (l) x 1,105mm (h) x730 mm (w)	Engelberg type coffee dehuller Dimension: Manufacturer's standard, should not exceed 2m (L) x 2m (W)
1 unit Automatic Band Sealer	Machine Size- 860 (l) x 420 (w) x 36 (h) mm	Machine Size: Manufacturer's standard, should not exceed 1.5m (L) x 1m (W)
3 units Stainless Steel Working Table	SS Type: 304	SS Type: Food Grade Stainless Steel 316



2. Attached as Annex 1 is the suggested design for the following fabricated equipment:

- 1 unit Coffee Bean Dryer
- 1 unit Coffee Dehuller Machine w/ Electric Motor
- 3 units Stainless-Steel Working Table
- 2 units Kiosk, STARBOOKS

This amendment shall form integral part of the Philippine Bidding Documents.

For the guidance and information of all concerned.

  
**RICARDO N. VARELA**  
Chairperson, BAC

# COFFEE BEAN DRYER: SOLAR TUNNEL DRYER FOR COFFEE

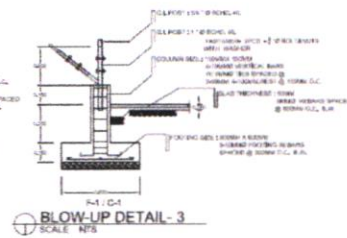
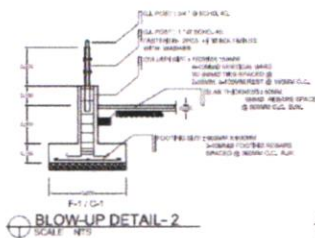
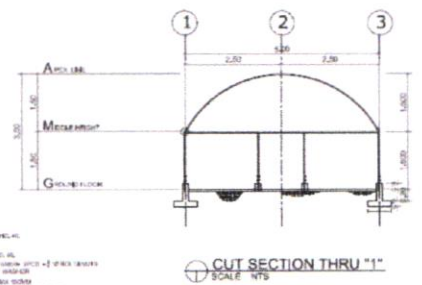
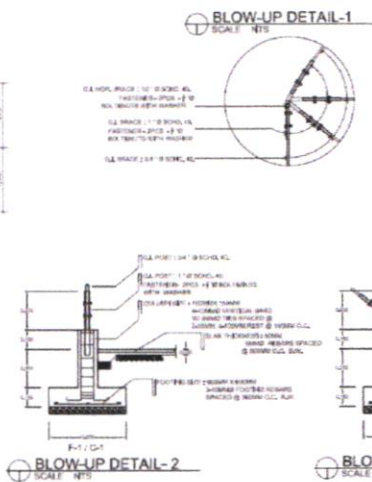
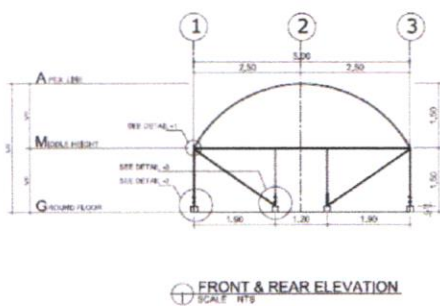
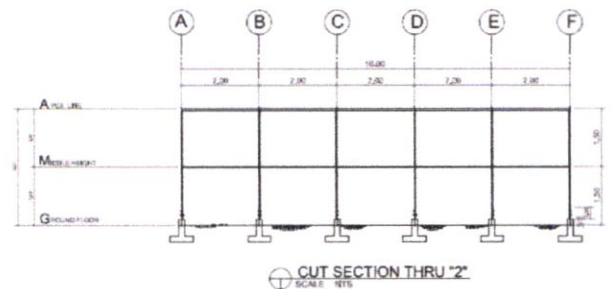
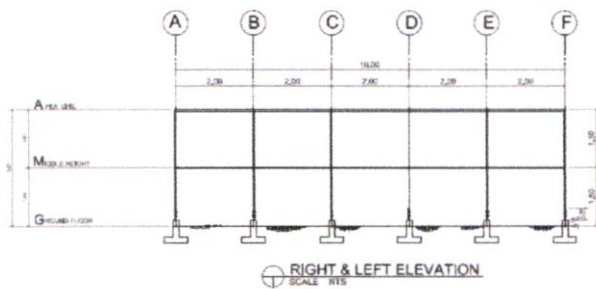
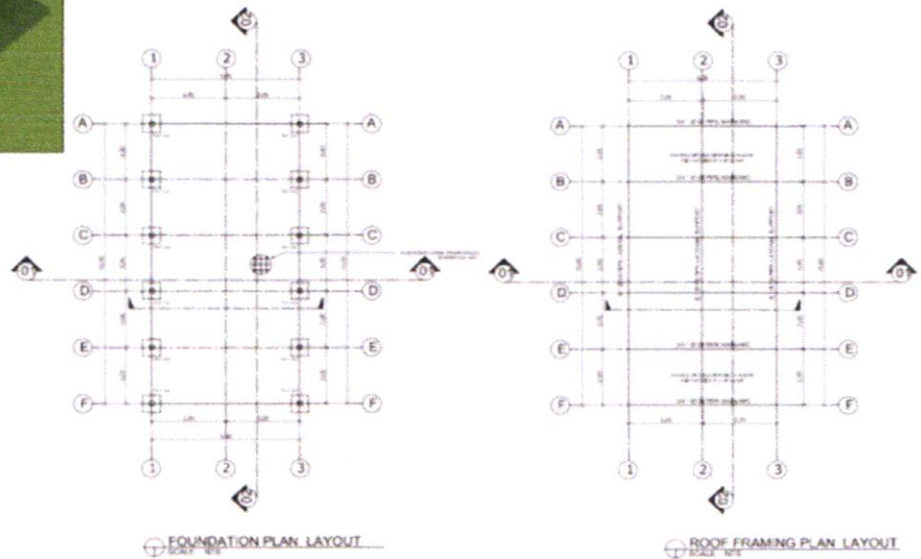
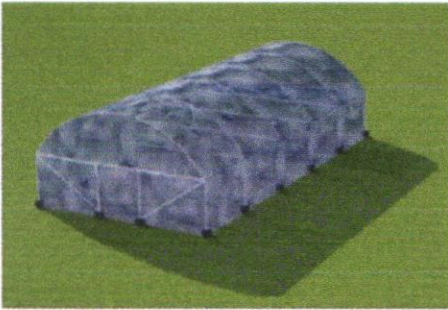

# COFFEE DEHULLER



**STAINLESS STEEL WORKING TABLE**

